



**PRODUCT  
CATALOG  
2024**

# **CONTENTS**

## **OPTICAL CASES**

<b>METAL CASES</b>	<b>4-11</b>
<b>SUNGLASS CASES</b>	<b>12-13</b>
<b>BUBBLE CASES</b>	<b>14</b>
<b>FANCY CASES</b>	<b>15</b>
<b>SOFT CASES</b>	<b>16</b>

## **MICROFIBER CLOTHS**

<b>MF HY CLOTHS</b>	<b>17-18</b>
---------------------	--------------

## **SPARES**

<b>NOSE PAD CLIPS &amp; SCREWS</b>	<b>19</b>
<b>SCREWS</b>	<b>20</b>

## **ACCESSORIES**

<b>EAR HOOKS</b>	<b>21-22</b>
<b>SPECTACLE CORDS</b>	<b>23</b>
<b>FRAME FOLD</b>	<b>24</b>



“ PROMOTE YOUR PRACTICE ALL YEAR ROUND BY GIVING YOUR CLIENTS A PRINTED CASE AND 2 CLOTHS. ONE FOR YOUR CLIENT AND ONE TO GIVE AWAY TO A FRIEND. THIS WILL REPEAT YOUR CLIENTS’ VISITS AND GET YOU NEW ONES. ”



**BEST PRICES**

We can beat any written quote.



**COLOR**

Various colours & design cases.



**PRINT & DESIGN SERVICES**

On spectacle cases & lens cloths.



**QUALITY**

We only stock the best quality products in the market.



**PROMOTION**

Leave an impression on your patients.  
Promote your brand.



# CASES

MODEL: S6 MATT

SIZE: 158-68-40

## METAL CASES

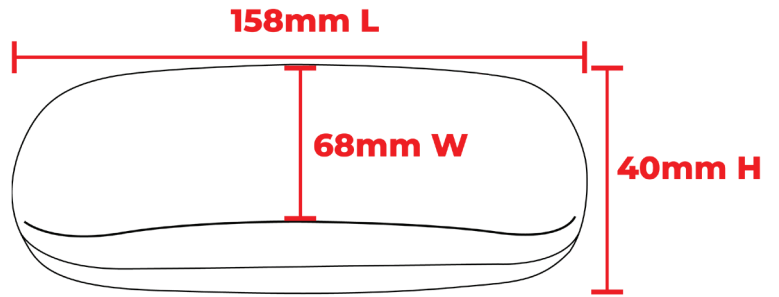

## DIMENSIONS

## COLOUR DISPLAY



C1 BLACK



C2 BROWN



C3 NAVY BLUE



# CASES

MODEL: J10 MATT

SIZE: 163-65-40

## METAL CASES

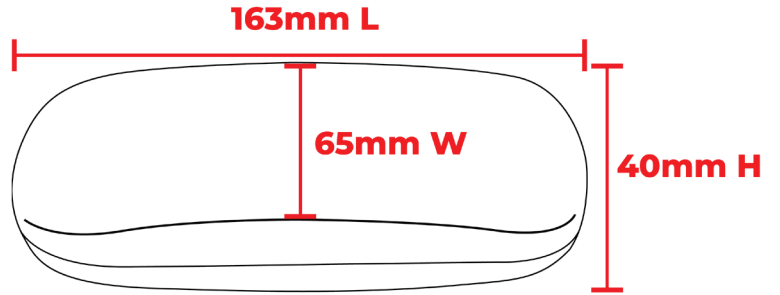

## DIMENSIONS

## COLOUR DISPLAY



C1 BLACK



C2 BROWN



C3 NAVY BLUE

# CASES

MODEL: J11 MATT

SIZE: 163-63-40

## METAL CASES

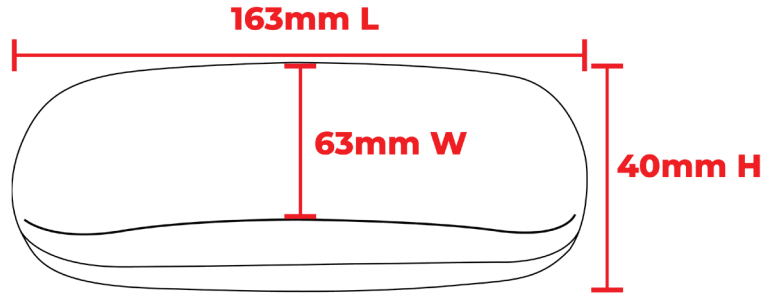

## DIMENSIONS

## COLOUR DISPLAY



C1 BLACK



C2 BROWN



C3 NAVY BLUE

# CASES

MODEL: J12 MATT

SIZE: 158-62-35

## METAL CASES

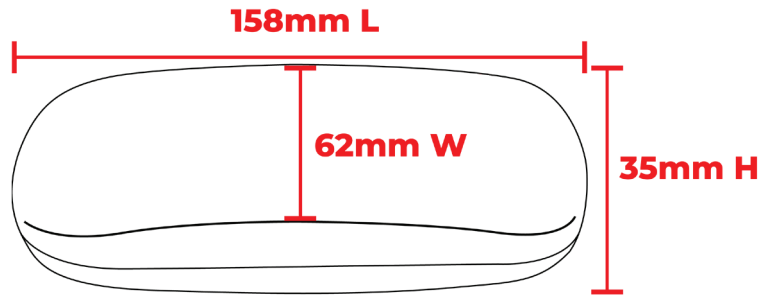
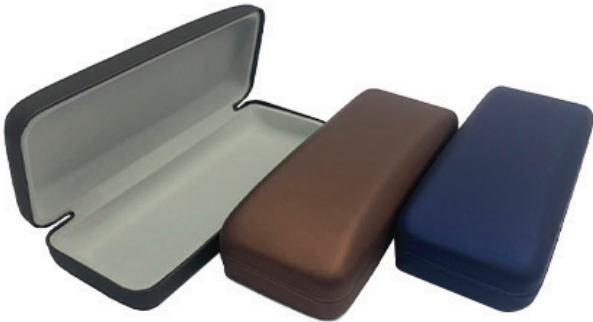

## DIMENSIONS

## COLOUR DISPLAY



C1 BLACK



C2 BROWN



C3 NAVY BLUE

# CASES

MODEL: A5

SIZE: 160-57-36

## METAL CASES

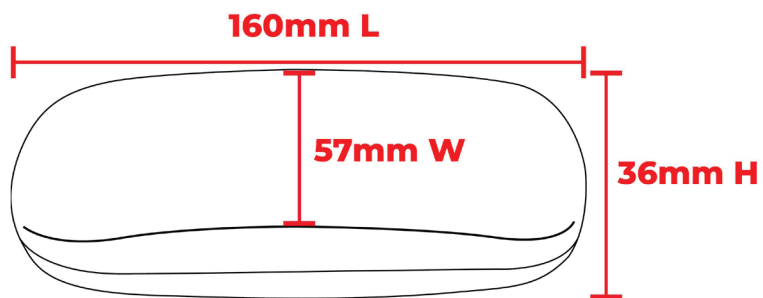
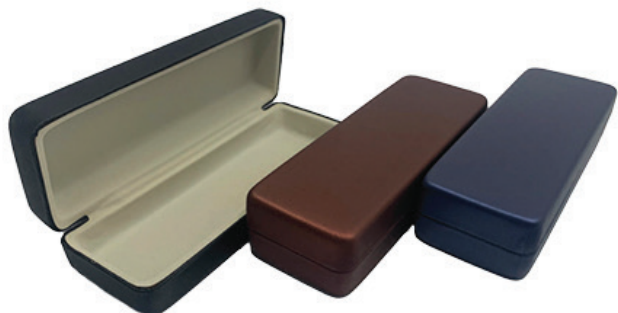

## DIMENSIONS

## COLOUR DISPLAY



C1 BLACK



C2 BROWN



C3 NAVY BLUE

# CASES

MODEL: B3 MATT

SIZE: 160-66-38

## METAL CASES

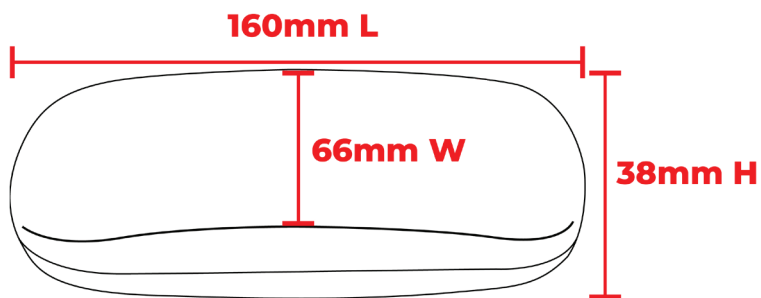

## DIMENSIONS

## COLOUR DISPLAY



C1 BLACK



C2 BROWN



C3 NAVY BLUE



# CASES

MODEL: B10

SIZE: 158-70-37

## METAL CASES

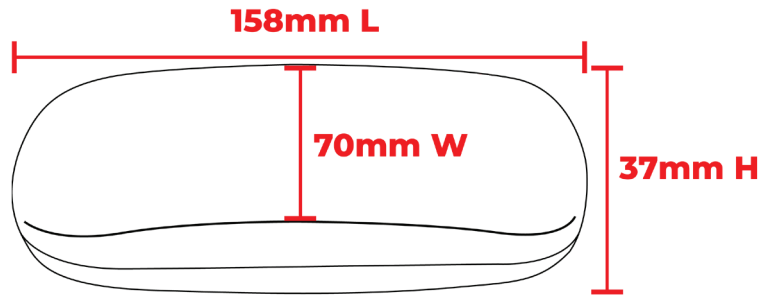

## DIMENSIONS

## COLOUR DISPLAY



C1 BLACK



C2 BROWN

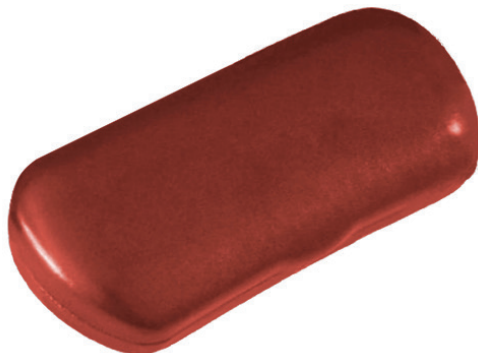

C3 Burgandy

# CASES

MODEL: S17 MATT

SIZE: 163-70-36

## METAL CASES

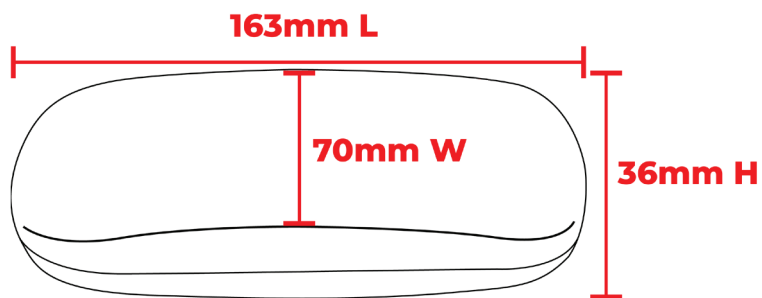

## DIMENSIONS

## COLOUR DISPLAY



C1 BLACK



C2 BLUE

# CASES

MODEL: S18

SIZE: 165-56-53

## SUNGLASS CASES

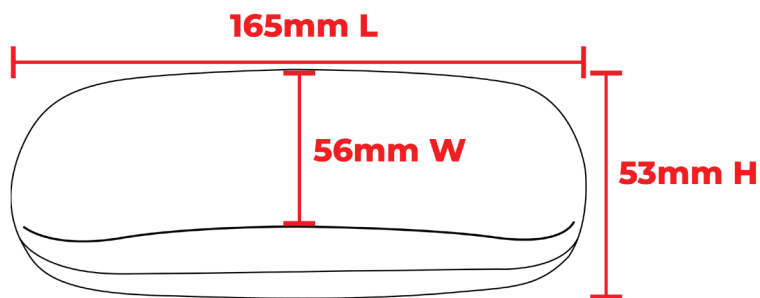

### DIMENSIONS

### COLOUR DISPLAY



C1 BLACK

# CASES

MODEL: S19

SIZE: 158-70-37

## SUNGLASS CASES

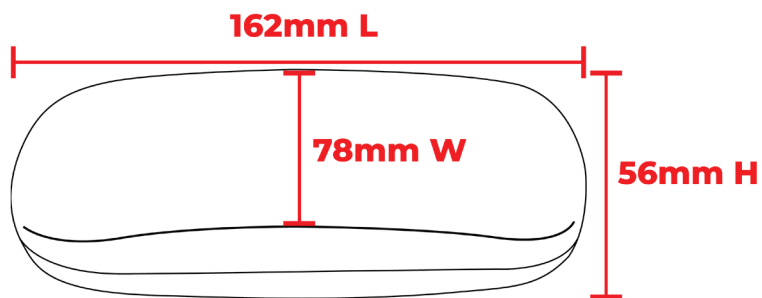

### DIMENSIONS

### COLOUR DISPLAY

---



C1 BLACK

# CASES

MODEL: BUBBLE 2

SIZE: 175-75-58

## BUBBLE CASES

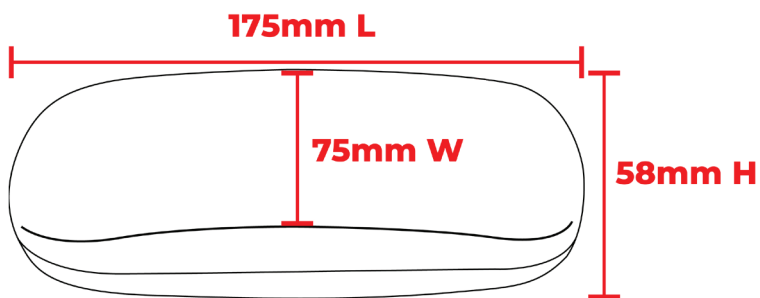

## DIMENSIONS

## COLOUR DISPLAY

---



C1 BLACK



# CASES

MODEL: S3 KIDDIES

SIZE: 160-66-38

## FANCY CASES

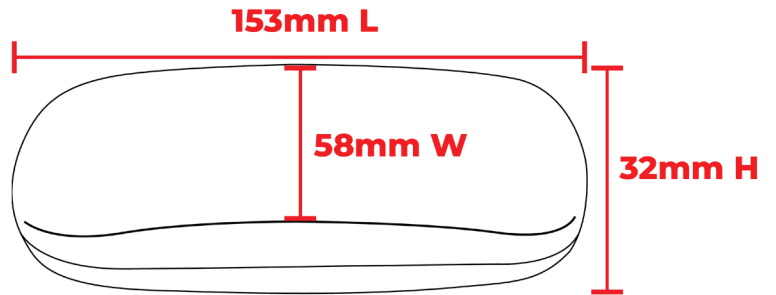

## DIMENSIONS

## COLOUR DISPLAY



C1 BLACK



C2 RED



C3 BLUE



C4 PURPLE

# CASES

MODEL: Z3 MF

SIZE: 170-93-30

## SOFT CASES

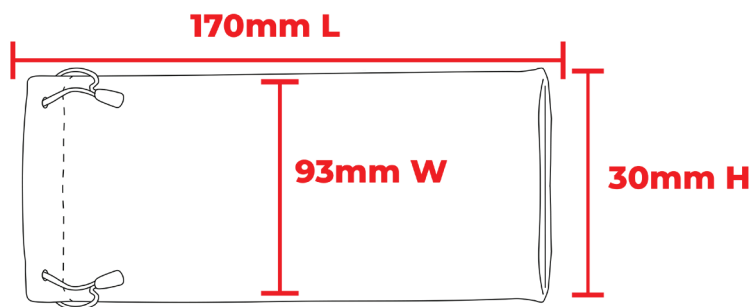

## DIMENSIONS

## COLOUR DISPLAY



C1 BLACK



C2 BLUE

# CLOTHS

MF HY MEDIUM

SIZE: 150-100

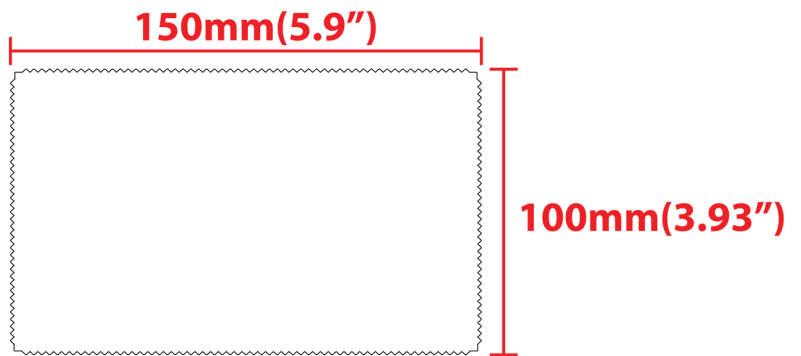
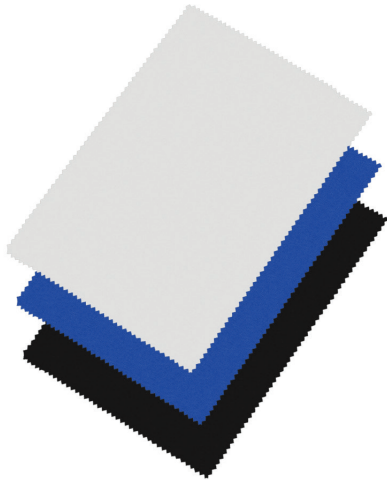

**DIMENSIONS**

## COLOUR DISPLAY

---

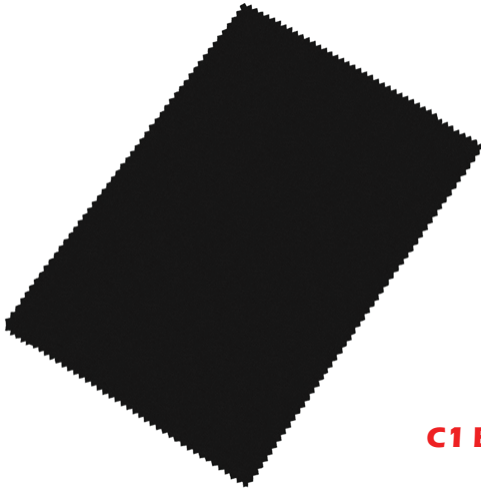

**C1 BLACK**

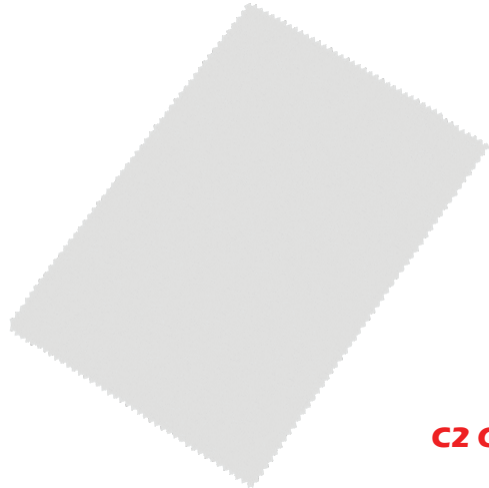

**C2 GREY**

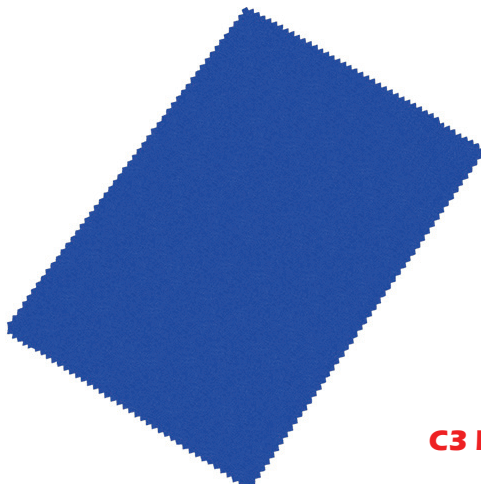

**C3 BLUE**

# CLOTHS

MF HY LARGE

SIZE: 160-160

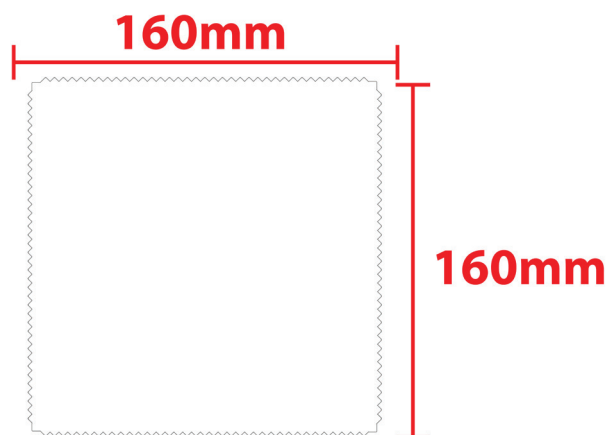
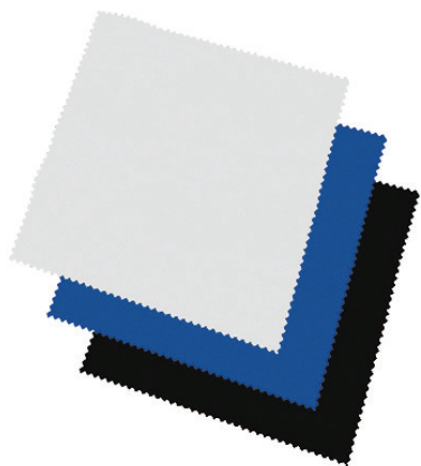

**DIMENSIONS**

## COLOUR DISPLAY

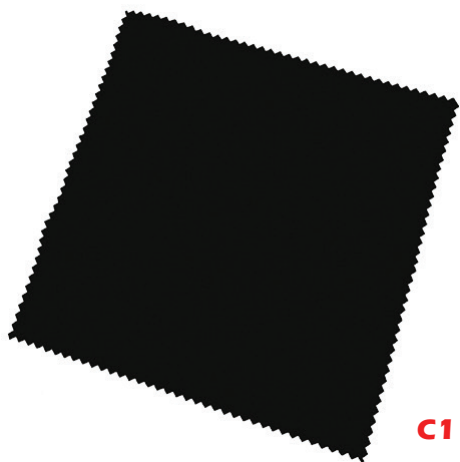

**C1 BLACK**

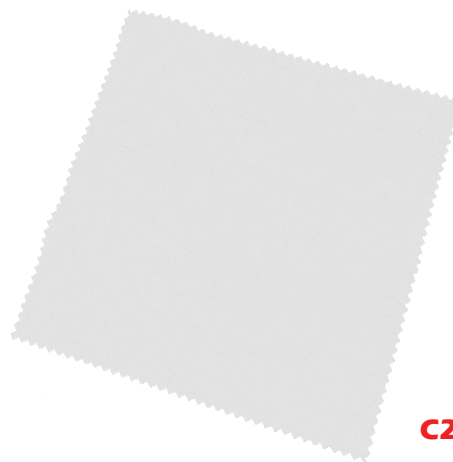

**C2 GREY**

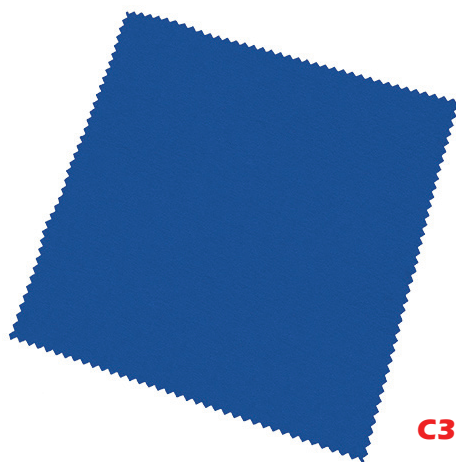

**C3 BLUE**

# SPARES

## NOSE PAD CLIPS & SCREWS

### OVAL SCREW IN



- 13.0 mm
- 15.0 mm
- 17.0 mm

### OVAL CLIP IN



- 13.0 mm
- 15.0 mm
- 17.0 mm

### ROUND SCREW IN



- 9.0 mm
- 11.0 mm

### ROUND CLIP IN



- 9.0 mm
- 11.0 mm

### TEAR DROP



- 13.0 mm
- 15.0 mm



# SPARES

## SCREWS

### SHORT



- **2.0x1.4x3.0mm**

### MEDIUM



- **2.0x1.2x4.0mm**
- **2.0x1.4x4.0mm**
- **2.0x1.6x4.0mm**

### NOSE PAD



- **1.6x1.2x4.5mm**
- **1.8x1.0x4.2mm**

# ACCESSORIES

## EAR HOOKS

**SMALL TEMPLE EAR HOOKS**  
**Premium Grade**

# SOFT SILICONE

**SIZE : 36.0MM**

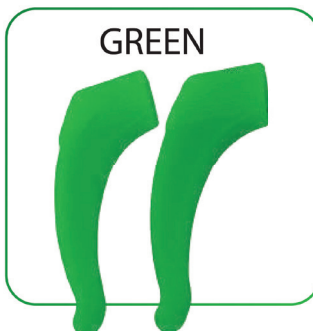

# ACCESSORIES

## EAR HOOKS

**LARGE TEMPLE EAR HOOKS**  
**Premium Grade**

# SOFT SILICONE

**SIZE : 42.0MM**

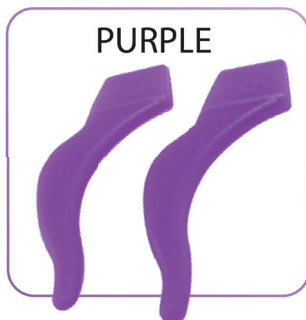
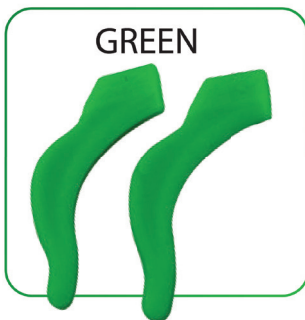
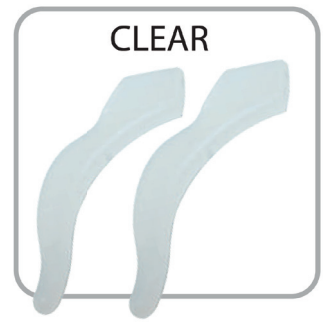
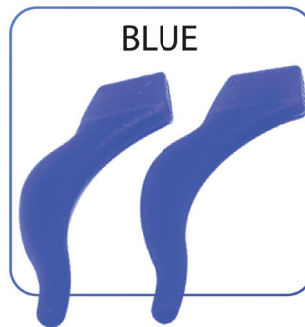
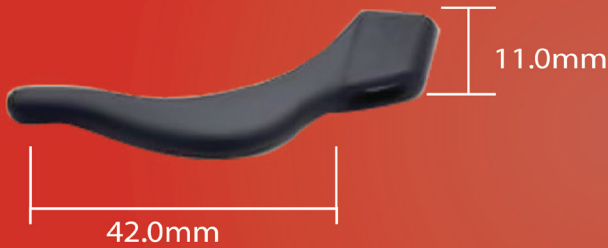

# ACCESSORIES

## SPECTACLE CORDS

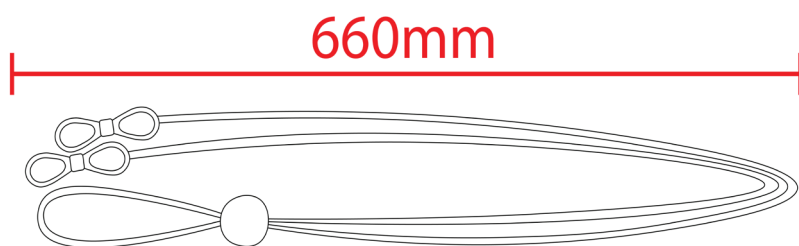
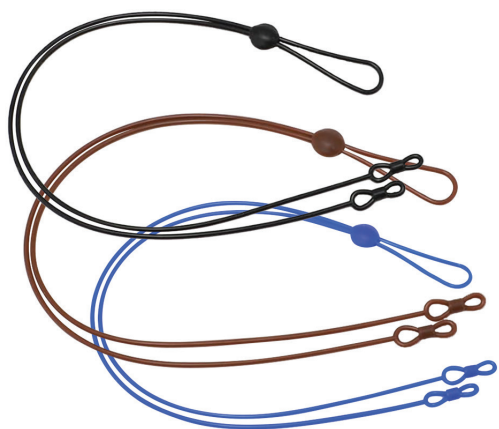

**DIMENSIONS**

**COLOUR DISPLAY**



**C1 BLACK**



**C2 BROWN**

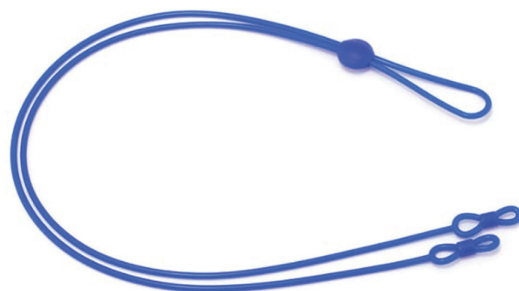

**C3 BLUE**



# ACCESSORIES

## FRAME FOLDERS



# FRAME FOLD

HANDY FRAME TEMPLE ADJUSTER



**AERO DYNAMIC SHAPE**  
**SILICONE RUBBER EDGES FOR EASY BENDING**

**MATERIAL: ALUMINIUM**  
**THICKNESS: 3mm**  
**SIZE: 130mmx15mm**



**BRIDGE  
ADJUST**



**TEMPLE  
ADJUST**



**RIM  
ADJUST**



**HINGE  
ADJUST**



